

Project Name:	
Type:	
Qty:	

Ring Light

Pendant / Surface



PRODUCT DESCRIPTION

The Ring Light is a versatile architectural lighting solution, available as a surface or pendant mount, with direct or direct/ indirect illumination. The Ring Light is available with 1,2 or 3 rings mounted from a single canopy. From 2ft dia to 16ft dia, the Ring Light stands out among the rest for range of features and options.

FEATURES

- Aluminum body construction
- 85 lumens per watt
- 120-277 volt
- 0-10v dimming
- Direct and Direct / Indirect LED light source
- Acoustic Option
- 60" adjustable suspension length

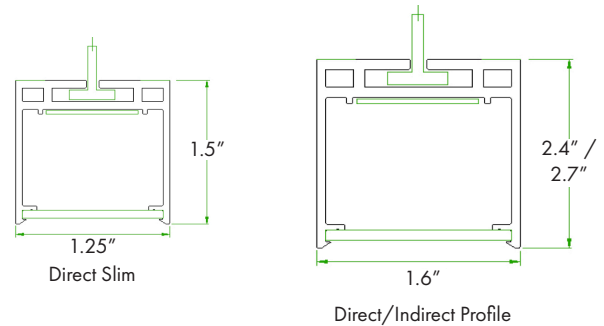
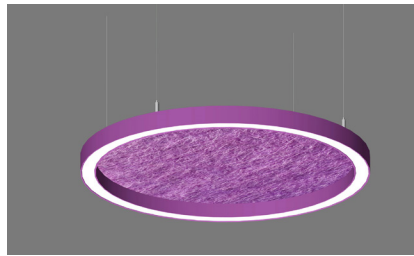
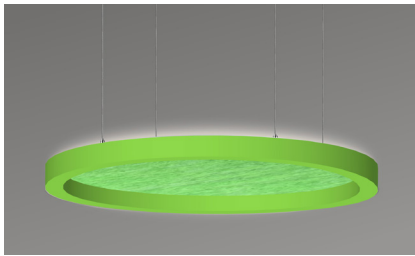
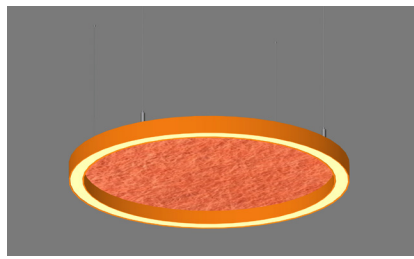

ORDERING INFORMATION

RL									
Fixture Type	Light Distribution	Mounting	CRI	Color Temp. Direct	Color Temp. Indirect	Size / Wattage	Dimming	Housing Finish	Options
RL Ring Light Series	DSL Direct Slim DI/ID Direct / Indirect	S Surface* CC Central Canopy DS Direct Suspension	9 90+ CRI	30K 3000 k 35K 3500 k 40K 4000 k	30K 3000 k 35K 3500 k 40K 4000 k NA Direct light only	2 2 ft. Dia. (600mm) = 40watts 3 3 ft. Dia. (900mm) = 50watts 4 4 ft. Dia. (1200mm) = 80watts 5 5 ft. Dia. (1500mm) = 100watts 6 6.5 ft. Dia. (2000mm) = 120watts 8 7.8 ft. Dia (2400mm) = 160watts 10 10 ft. (3000mm) = 200watts 12 11.8ft. (3600mm) = 240watts 14 13.8ft. (4200mm) = 320watts 16 16.5 ft. (5000mm) = 400watts	STD Standard Non-Dimming DIM 0-10v Dimming	BK Black WH White SLV Silver RD Red BL Blue GR Green YL Yellow PW Walnut C Cherry O Oak M Maple S Santos RAL xxx Custom RAL	*AC-XXX Acoustic (color code on page 3) EM15 Emergency Battery Backup (approx. 1050 lm)
		* Surface mount for direct light distribution only				** For multiple rings, list the sizes from largest to smallest. Example: 10/5/2		* Consult NAL for custom color options.	* Additional cost associated with premium wood finish acoustic textures. (etc. OX codes) Acoustic available in the following sizes only: DSL: 2,3,4,5,6,8ft DI/IN: 3,4,5,6,8ft

Project Name:	
Type:	
Qty:	

Ring Light

NUMBER OF SECTIONS & SUSPENSION POINTS

2' & 3' Dia.

1 section / 3 mounting points

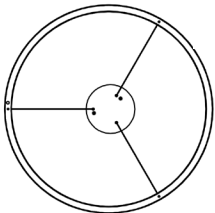

Direct = 1 Driver

4' & 5' Dia.

1 section / 4 mounting points

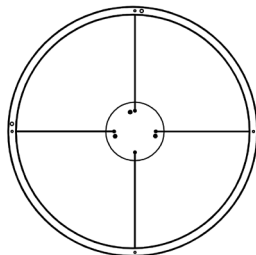

Direct = 2 Drivers
Direct/Indirect = 3 Drivers

6' Dia.

3 Sections / 6 Mounting Point

Direct = 3 Driver
Direct/Indirect = 4 Drivers

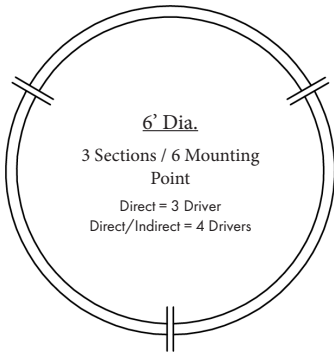

10' Dia.

5 Sections / 10 Mounting Point

Direct = 5 Driver
Direct/Indirect = 7 Drivers

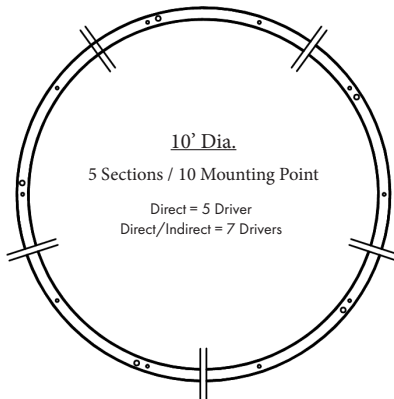

16ft.

6 Sections / 12 Mounting Point

Direct = 9 Driver
Direct/Indirect = 11 Drivers

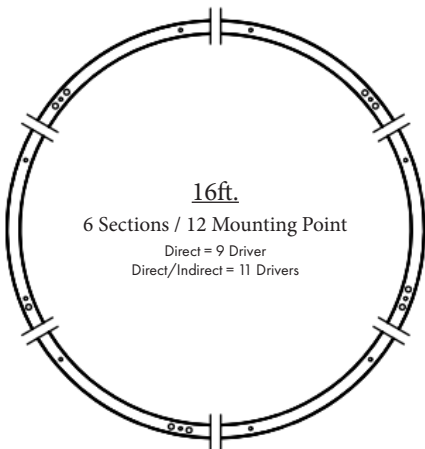

CANOPY DIMENSIONS

Size	Diameter	Height
2ft, 3ft	10"	1.75"
4ft, 5ft, 6ft	14"	1.75"
10ft, 16ft	20"	1.75"

PHOTOMETRY

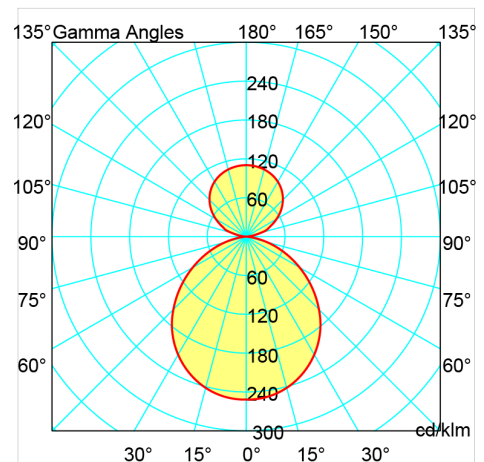
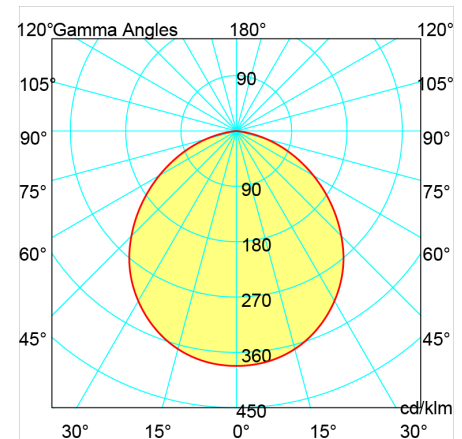

DELIVERED LUMENS

Size	Direct Only		Direct / Indirect	
	Lumens	Watts	Lumens	Watts
2ft.	3,400	40	4,500	50
3ft.	4,250	50	5,800	65
4ft.	6,800	80	9,000	100
5ft.	8,500	100	12,150	135
6ft.	10,200	120	13,500	150
8ft.	13,600	160	16,000	200
10ft.	16,000	200	25,500	260
12ft.	20,400	240	27,000	320
14ft.	25,500	320	34,000	400
16ft.	34,000	400	40,800	480

Project Name:	
Type:	
Qty:	

FINISHES

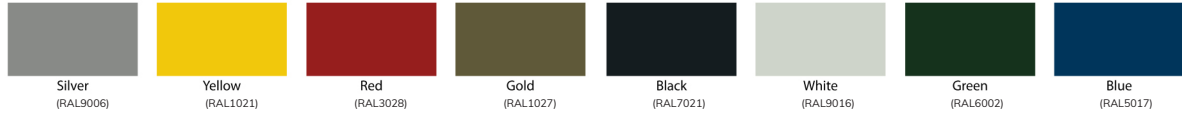

ACOUSTIC COLORS

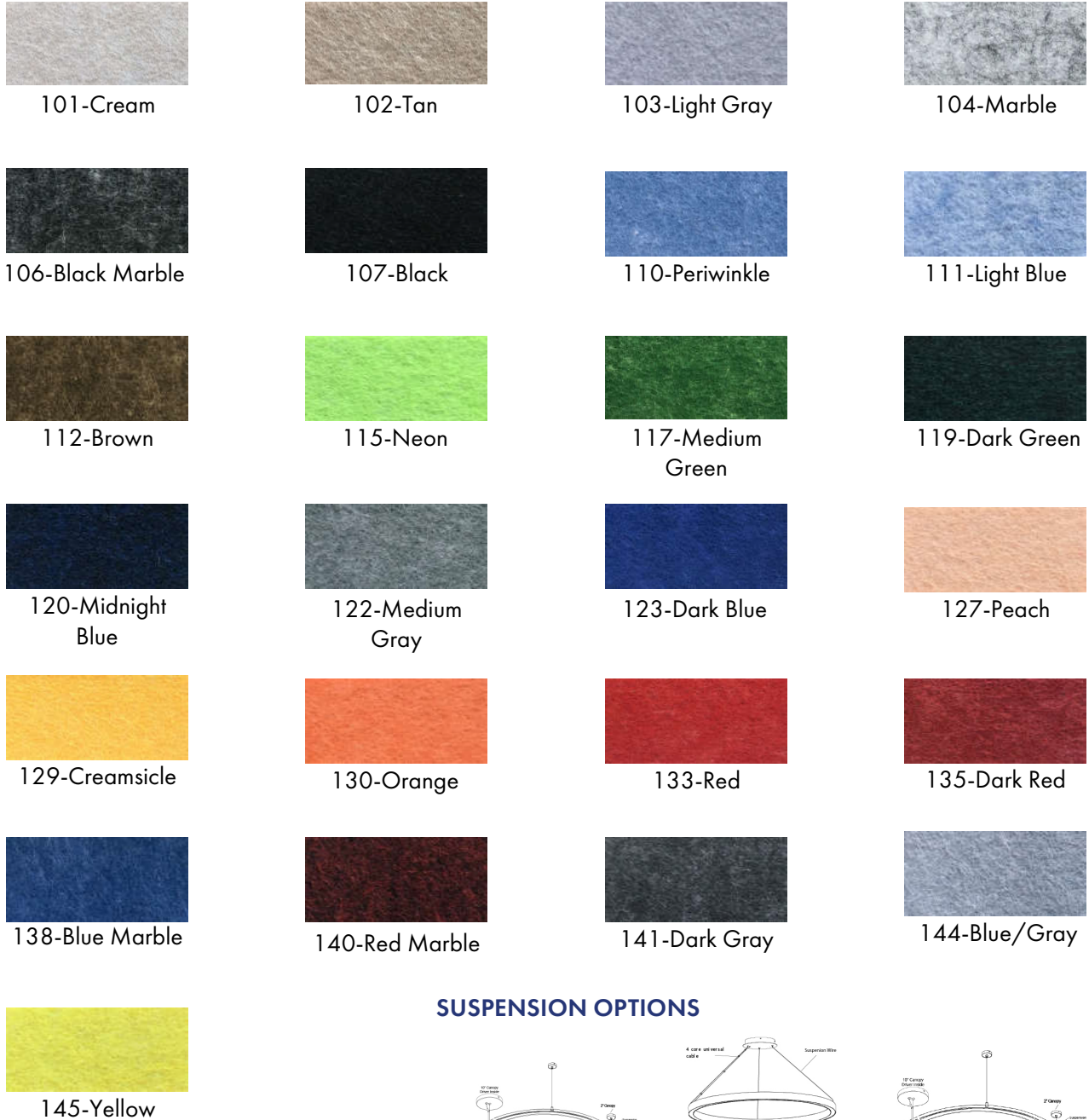

SUSPENSION OPTIONS

